

# Morning Basket



Construction Edition



# Color By Number

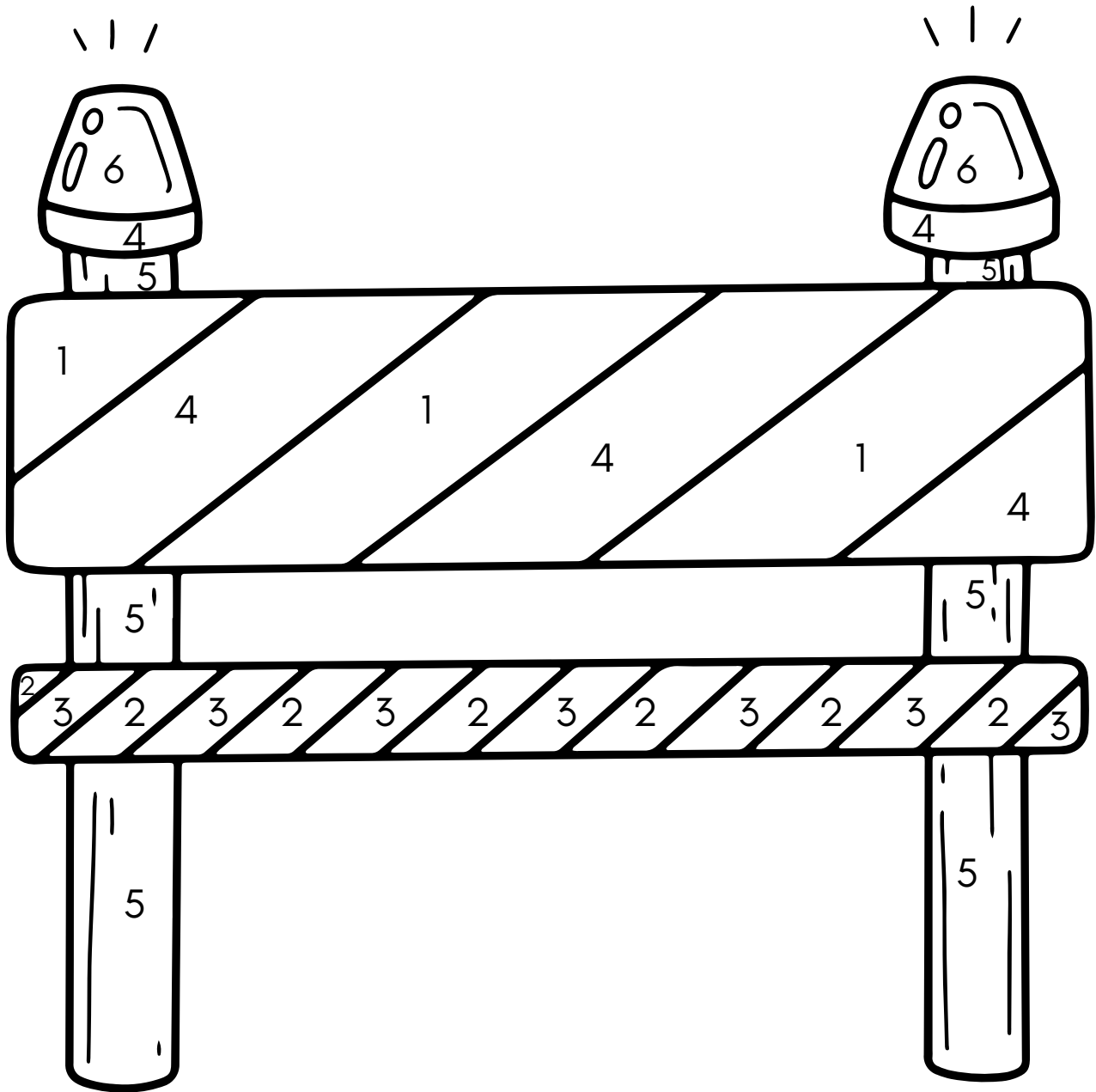

1: Yellow

2: Yellow-Orange

3: Orange

4: Black

5: Brown

6: Red

# Scissor Skills

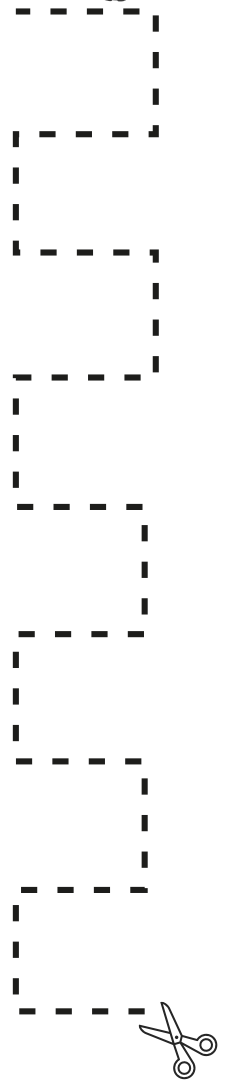
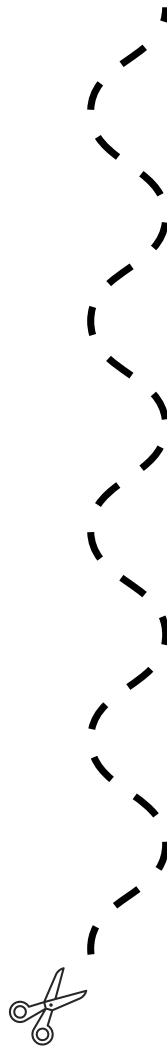
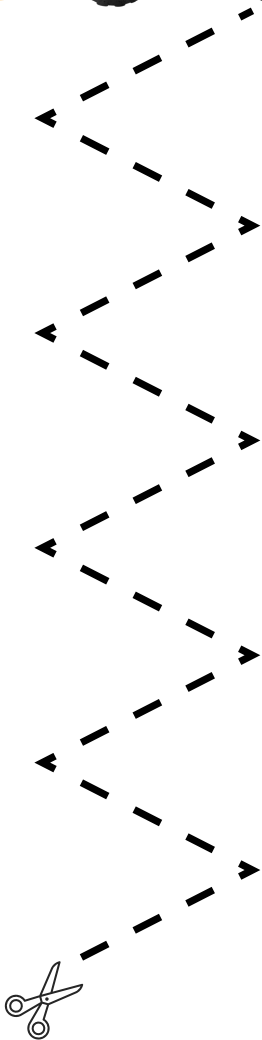

Cut along the dotted line.

# Scissor Skills

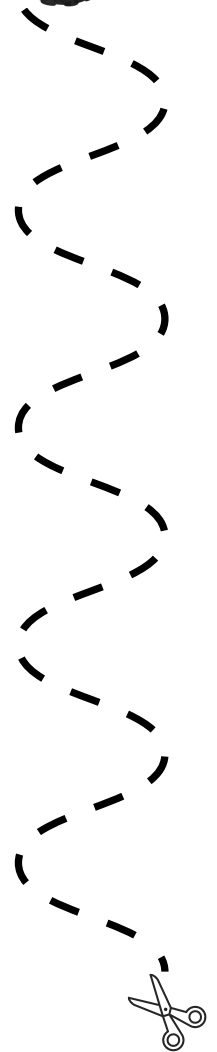
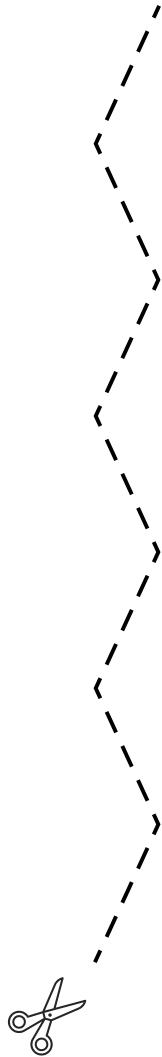
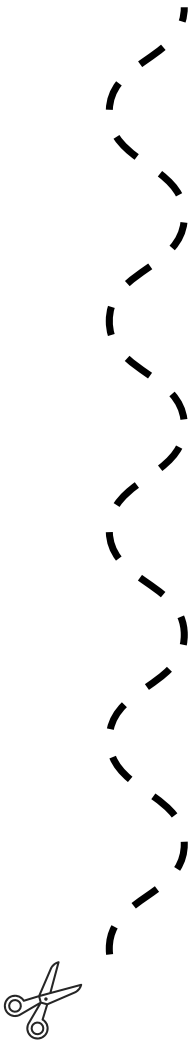

Cut along the dotted line.

# Count the Signs

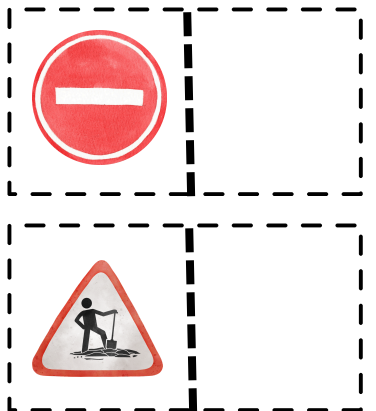
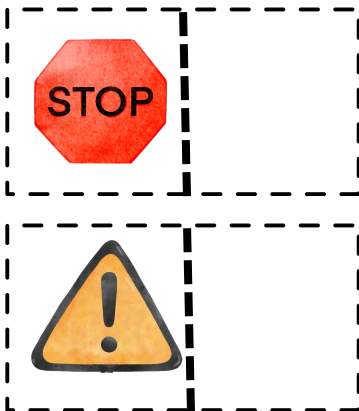
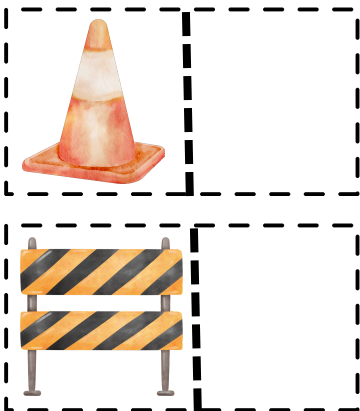
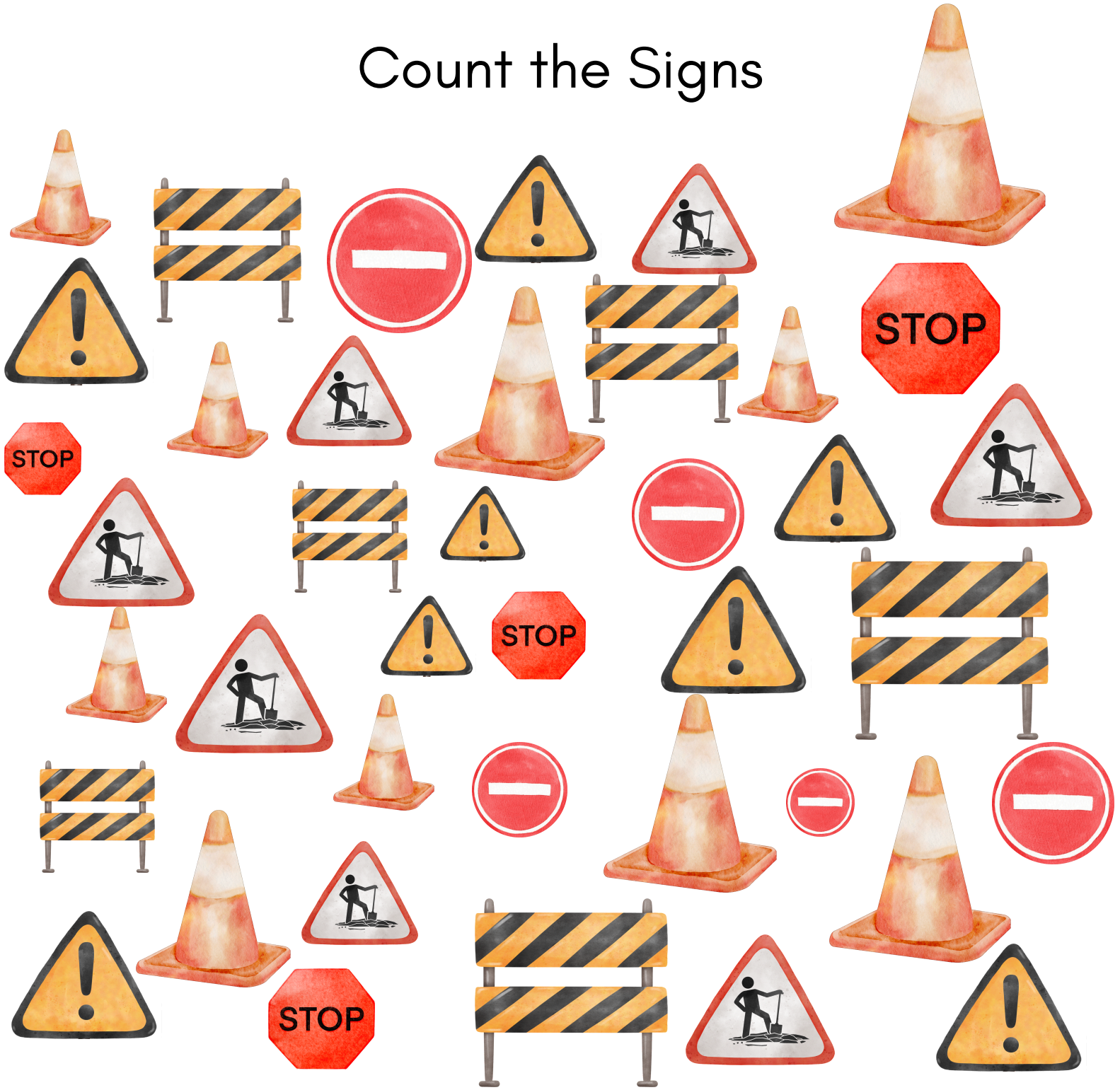

# Count the Tools

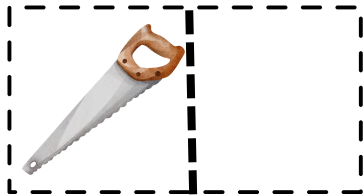
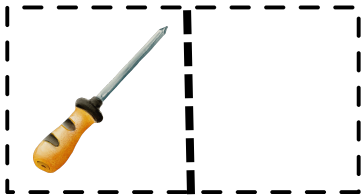
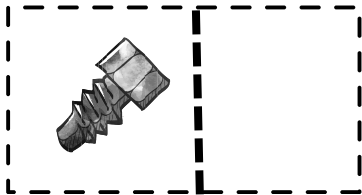
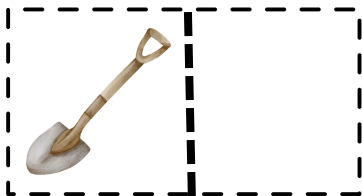

# Maze Challenge

Help get the excavator to the pile of dirt.

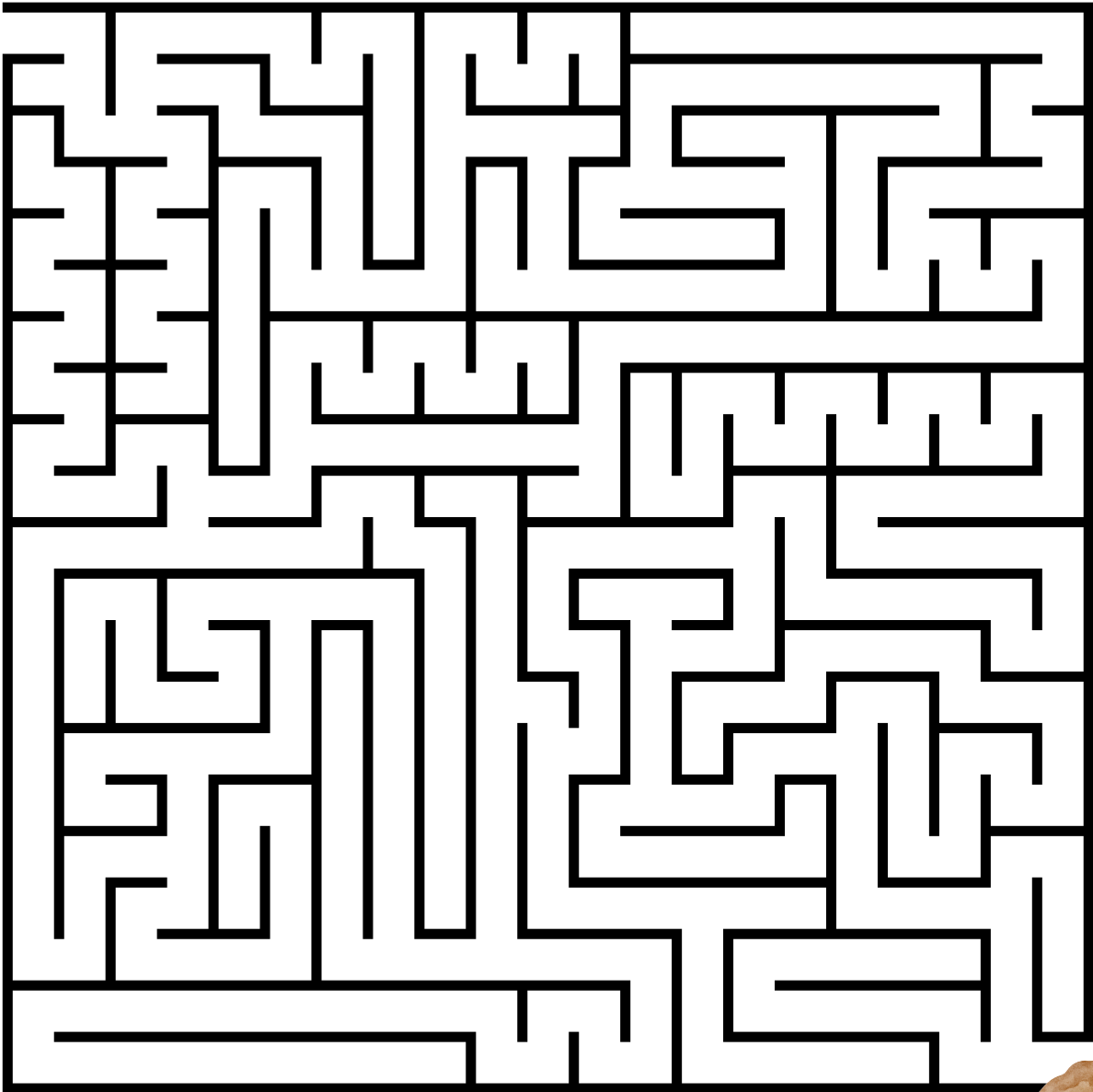

# Maze Challenge

Can you get to the missing traffic cone?

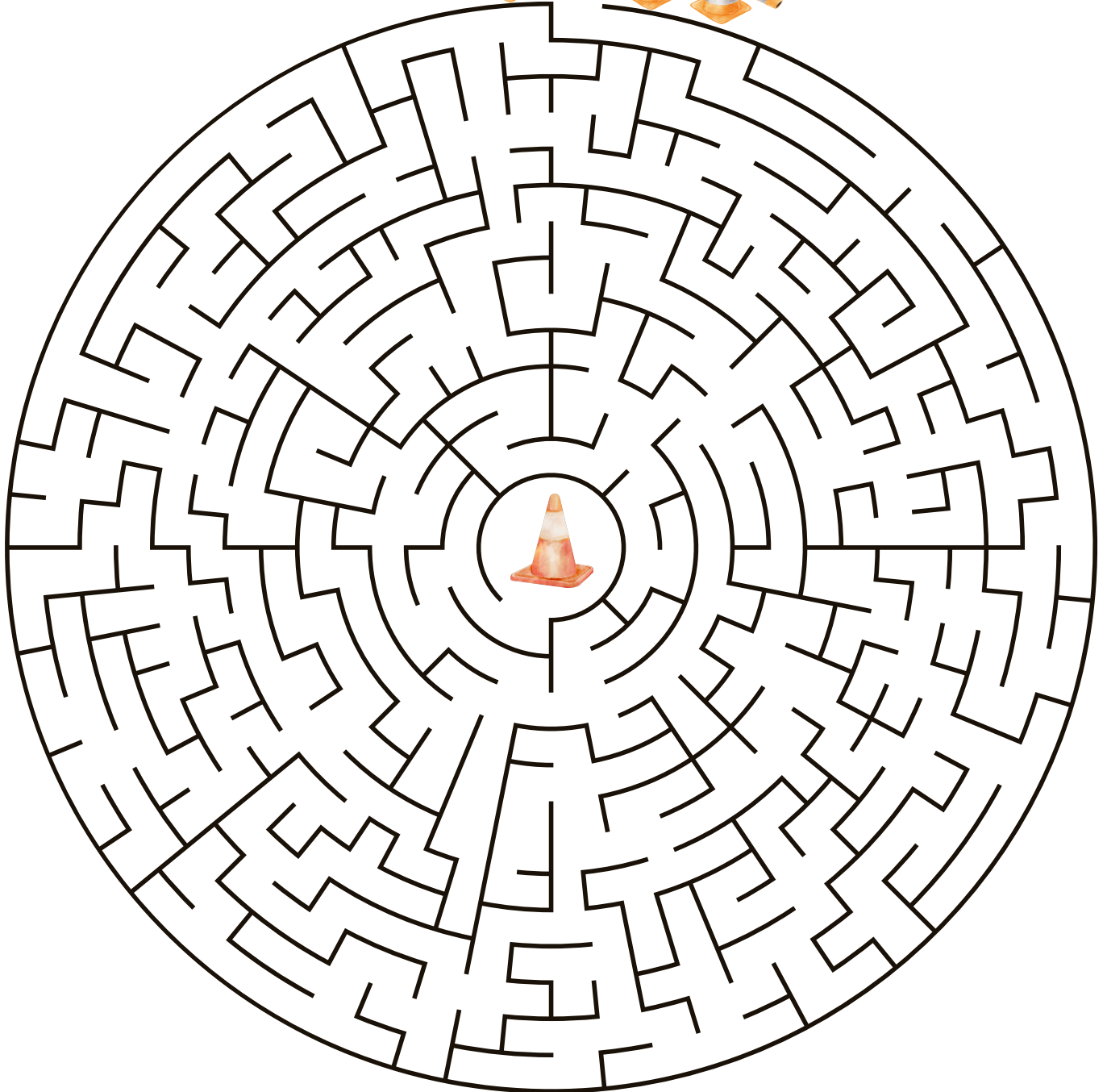
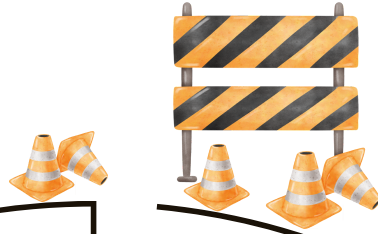

# Scissor Skills

Cut out the rocks below.  
Paste them into the dump truck on the following page.



# Fill the Dump Truck

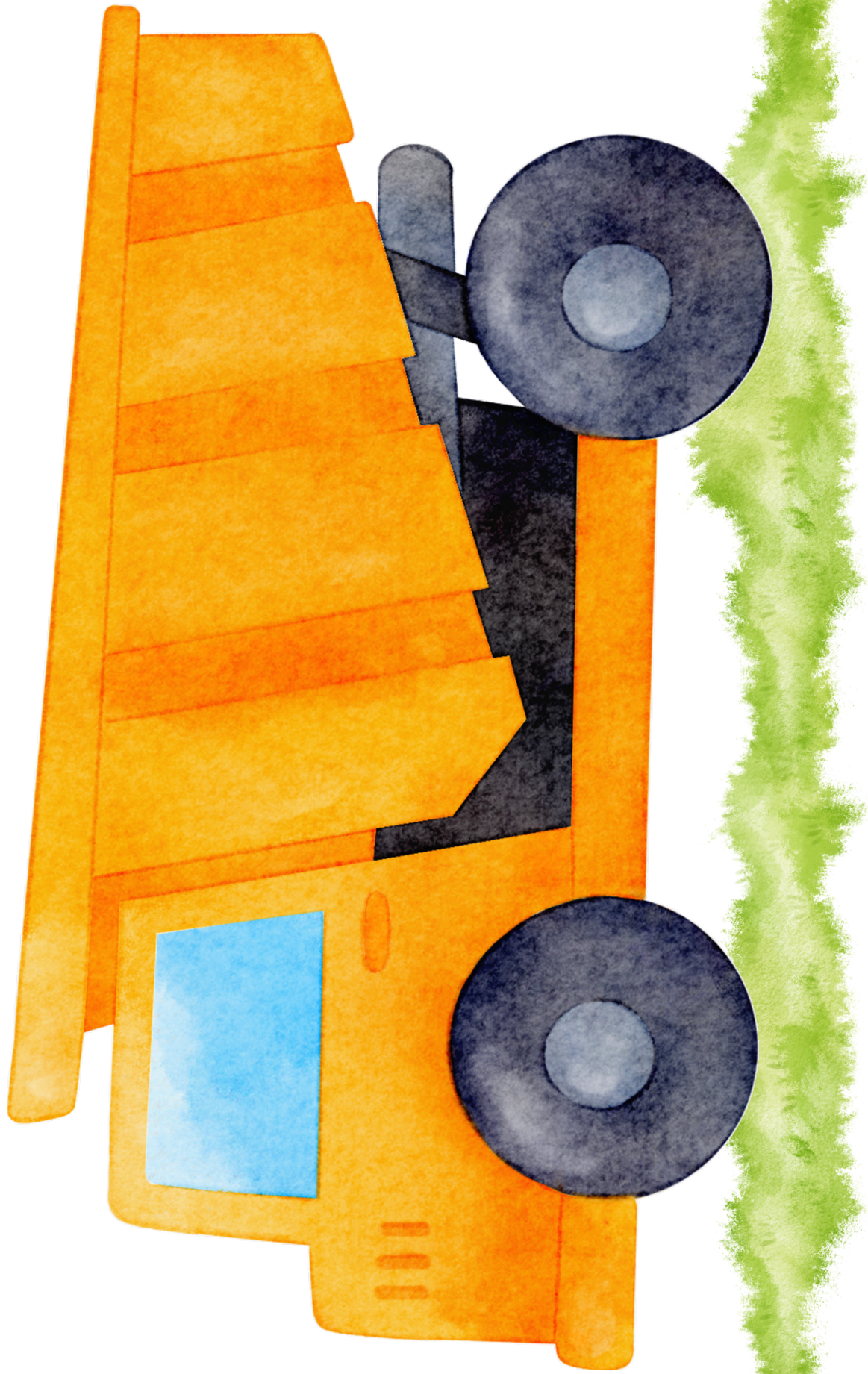

# My Toolbox

Cut out your favourite tools.  
Paste them onto the toolbox on the following page.

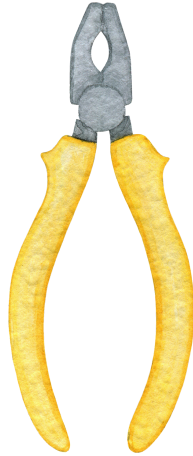

# My Toolbox



Color the Picture

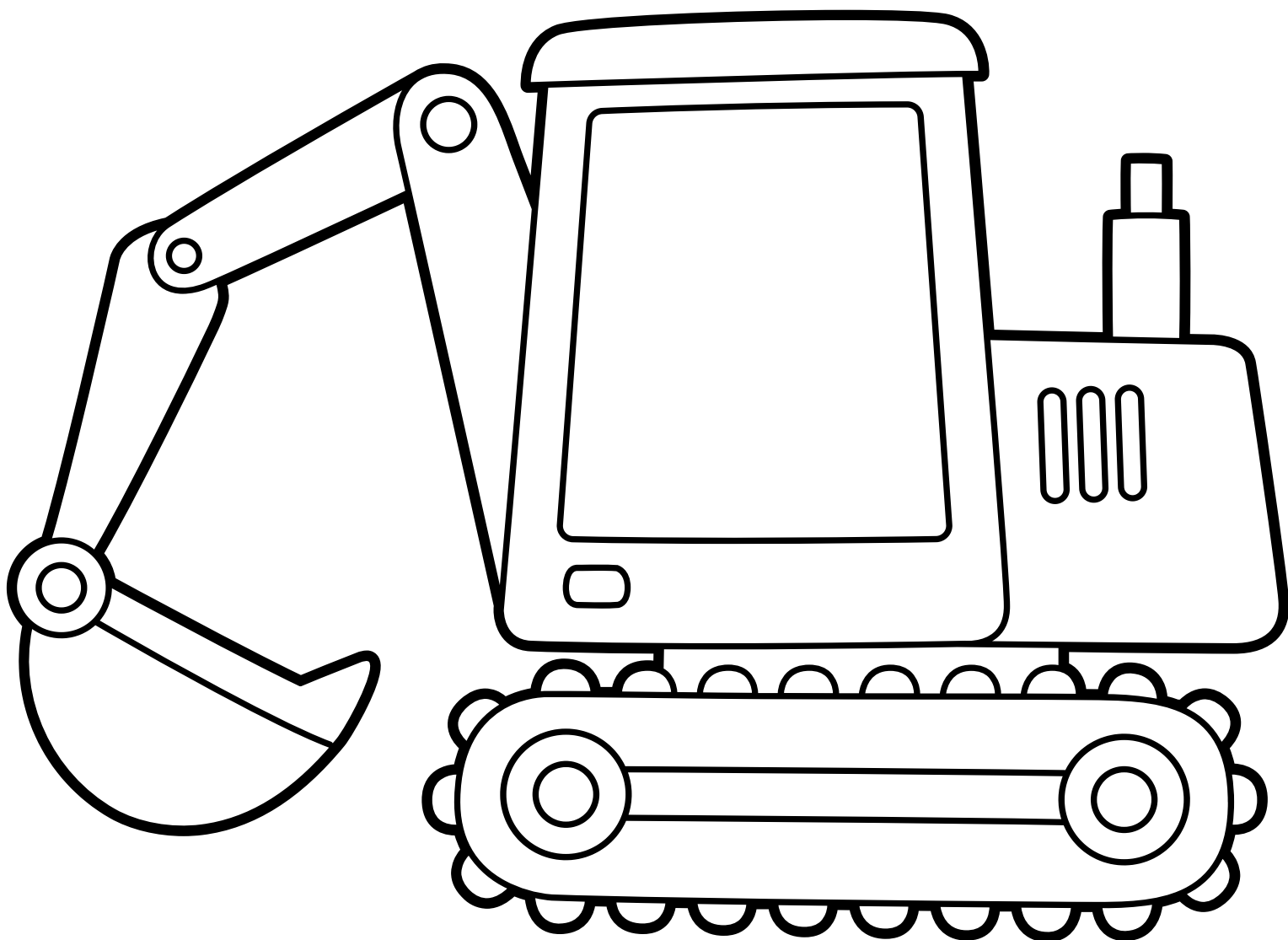

Color the Picture

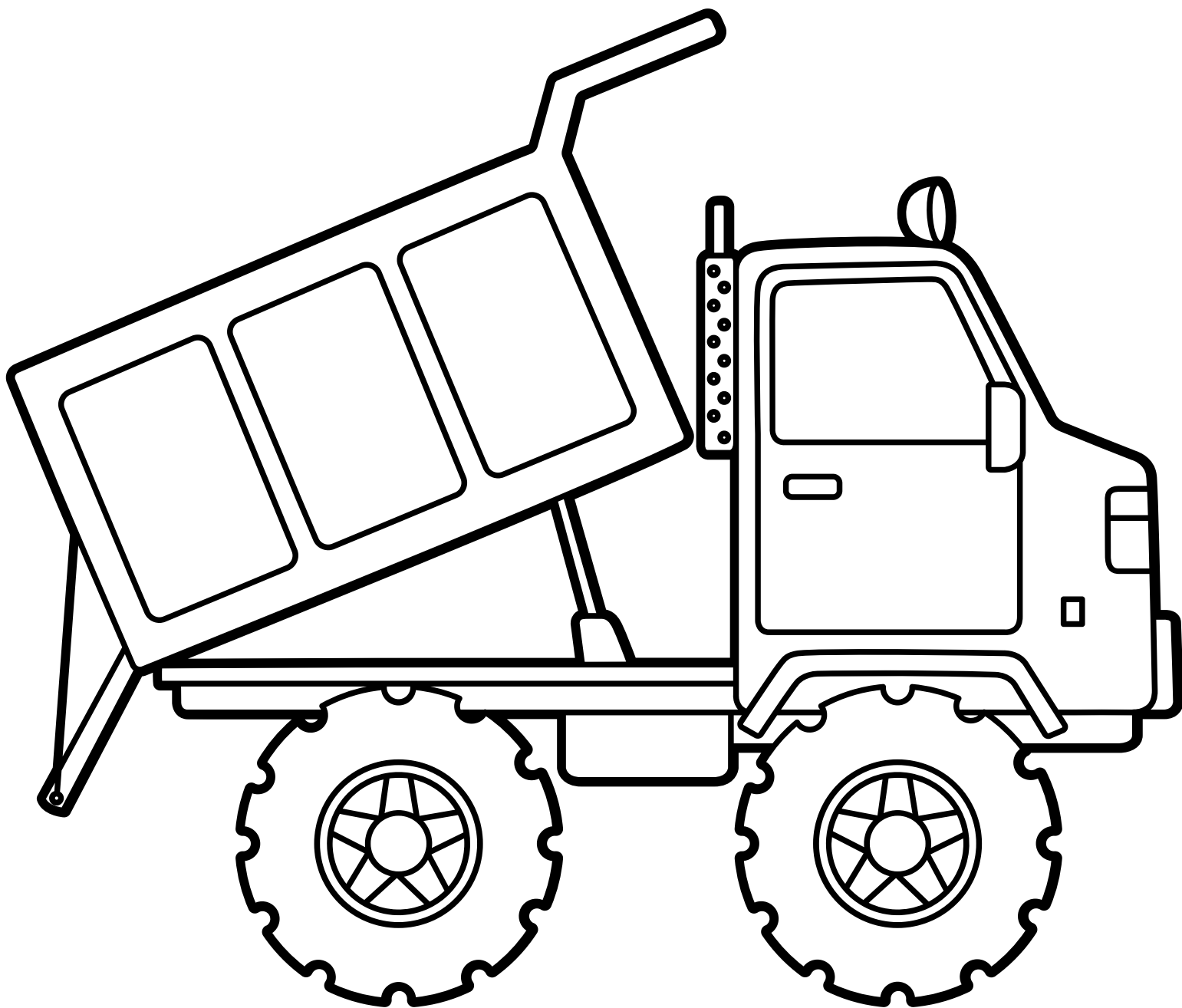

# Scissor Skills

Cut out the pieces below.  
Paste them onto the road on the following page.

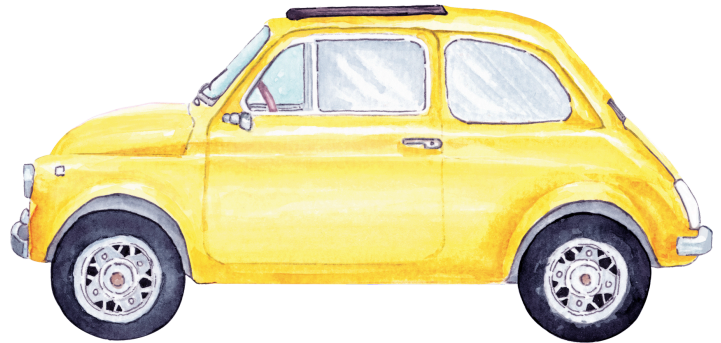
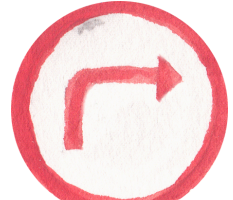
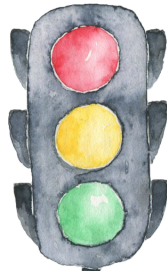

# My Road





# Playdough Mat

Use playdough to pave the road.



# Playdough Mat

Use playdough to make rocks for the excavator to move.

